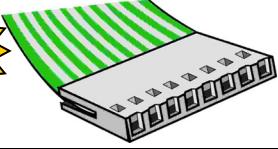
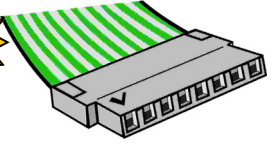

Connector Interface Selection Guide

On FPC/FFC side (SSI):

On PCB side (Customer):

Pitch: .100" Description: Female, Non-Latching	
Manufacturer:	Part Numbers:
<u>Nicomatic</u> 	OF-XX
<u>FCI</u> 	65801-XXX

IN STOCK

IN STOCK

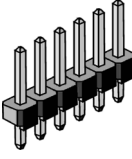
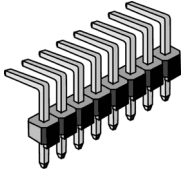

Pitch: .100" Description: Male Header (.025" sq. pins)	
Details:	Sources:
<u>Straight</u> 	www.nicomatic.com www.molex.com www.fciconnect.com www.digikey.com
<u>Right Angle</u> 	www.nicomatic.com www.molex.com www.fciconnect.com www.digikey.com

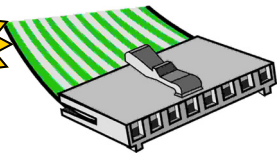
Pitch: .100" Description: Female, Latching	
Manufacturer:	Part Numbers:
<u>Nicomatic</u> 	OL-XX

IN STOCK

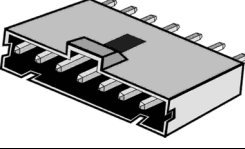

Pitch: .100" Description: Male, Latching	
Manufacturer:	Sources:
<u>Nicomatic</u> 	www.nicomatic.com

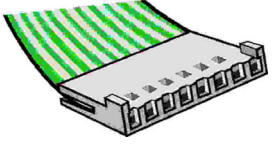
Pitch: .100" Description: Female, Polarized w/Detent	
Manufacturer:	Part Numbers:
<u>Nicomatic</u> 	1E-XX

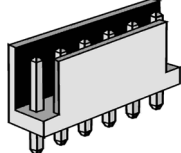

Pitch: .100" Description: Male Header	
Manufacturer:	Sources:
<u>Nicomatic</u> 	www.nicomatic.com

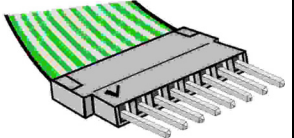
Pitch: .100" Description: Male, Non Latching	
Manufacturer:	Part Numbers:
<u>FCI</u> 	66226-XXX

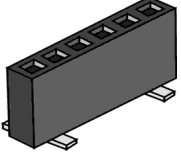

Pitch: .100" Description: Female Header	
Manufacturer:	Sources:
<u>Nicomatic</u> 	www.nicomatic.com

On FPC/FFC side (SSI):

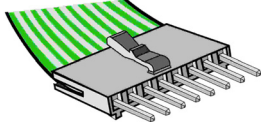
Pitch: .100" Description: Male, Latching	
Manufacturer:	Part Numbers:
<u>Nicomatic</u> 	OL-XX

MATES WITH

On PCB side (Customer):

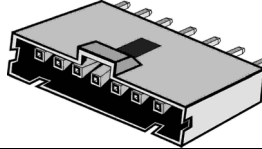
Pitch: .100" Description: Female Header, Latching	
Manufacturer:	Sources:
<u>Nicomatic</u> 	www.nicomatic.com

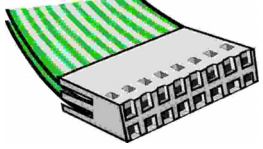
Pitch: .100" Description: Dual Row Header	
Manufacturer:	Part Numbers:
<u>Nicomatic</u> 	4F-xx

MATES WITH

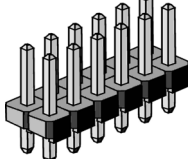
Pitch: .100" Description: Thru-Holes in PCB (.080" dia.)	
Details:	Sources:
<u>Dual Row Male Header</u> 	www.nicomatic.com www.molex.com www.fciconnect.com www.digikey.com

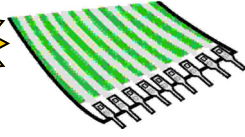
Pitch: .100" Description: Solder Tabs	
Manufacturer:	Part Numbers:
<u>Nicomatic</u> 	10241

MATES WITH

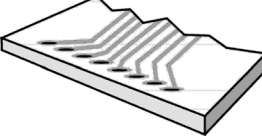
Pitch: .100" Description: Thru-Holes in PCB (.080" dia.)	
Manufacturer:	Sources:
<u>NA</u> 	NA

IN STOCK

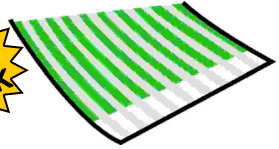
Pitch: .039" (1mm), .050", .100" Description: Bare Conductor	
Manufacturer:	Part Numbers:
<u>NA</u> 	NA

MATES WITH

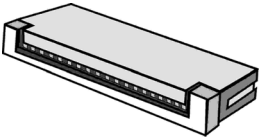
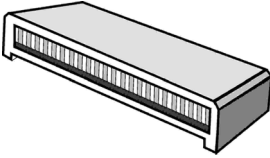
Pitch: .039" (1mm), .050", .100" Description: Header	
Details:	Sources:
<u>ZIF Style</u> 	www.molex.com www.fciconnect.com www.digikey.com
<u>LIF Style</u> 	www.molex.com www.fciconnect.com www.digikey.com

IN STOCK



www.ssielectronics.com

Phone: 800-866-8510 Fax: 616/866-8882
8080 Graphic Drive, NE Belmont, MI 49306